

• **30<sup>th</sup> Edition** •

*Est. 1980*

*Keep Your Electronics Safe in a . . .*

**STRONGBOX<sup>®</sup>**

**Heavy-duty Rack-mount Chassis**

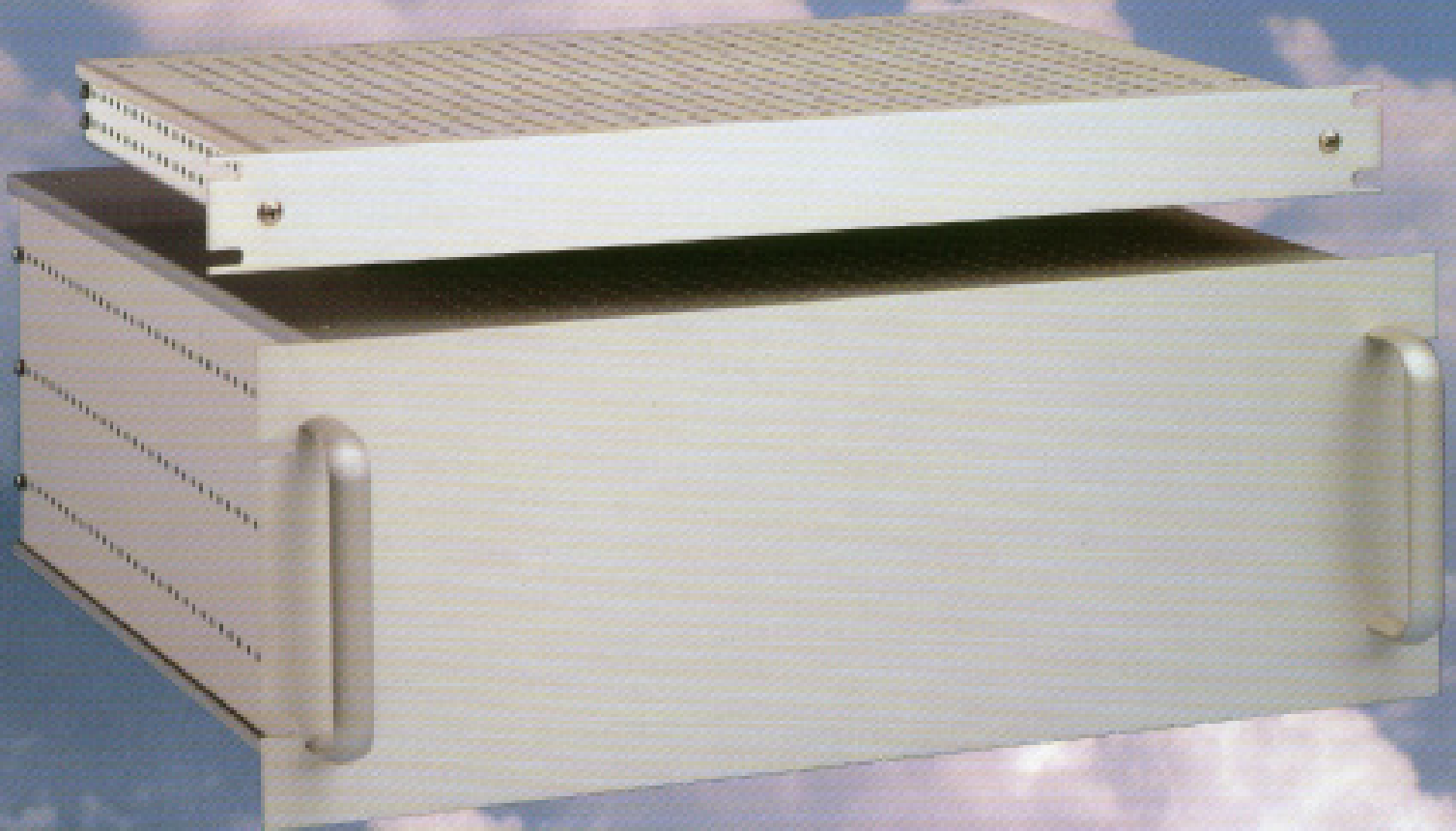

**phone: 310.305.8288**

**sales@RackMountChassis.com**

**"Home of the STRONGBOX<sup>®</sup>"**

© 2021



# **STRONGBOX®**

## **Heavy-duty Rack-mount Chassis**

### **Why do I need a heavy-duty chassis?**

Are you packaging power supplies or other heavyweight electronics? Will your assembly have to be taken apart and put back together again frequently? Will your equipment be air-, land-, or sea-mobile or otherwise subjected to physical stress? Do you need the ruggedest possible Mil-Spec enclosure, but at a reasonable price? You need to specify **STRONGBOX®**!

The most obvious difference between **STRONGBOX®** Heavy-duty Rack-mount Chassis and “regular-duty” versions offered by other manufacturers is the thickness of the aluminum from which they are made. The main structural members of our chassis are **0.090"**-thick. Similar parts of other units are only 0.040" to 0.063". Our heavy-duty chassis provide more than twice the intrinsic strength without using hard-to-machine steel or added internal framework sub-assemblies.

Specify **STRONGBOX®** to keep your project hassle-free.

Our **Heavy-duty Rack-mount Chassis** easily assemble with stainless steel machine screws, lockwashers, and captive PEM nuts which do not react galvanically with aluminum. Many other chassis use thinly plated, carbon steel, sheet metal screws or loose bolts and nuts. Captive machine hardware goes together precisely, solidly, and permanently. Sheet metal screws have been known to vibrate loose, or spontaneously disassemble when worn plating permits an electrolytic reaction with chassis metal.

Besides the materials used in manufacture and the hardware used for assembly, **STRONGBOX®** chassis configurations are engineered to support greater static and dynamic loads. Main load-bearing panels are stiffened and supported by wide flanges and from six to ten sets of hardware, and are anchored to two support panels of equal or superior strength. The resulting chassis are rigid, solid, cohesive unit-structures which support and protect their contents under extremely stressful conditions.

Protect your electronics inside a chassis built like a bank vault, but don't spend a fortune to do it. Specify **STRONGBOX®**!

**For Price and Performance, specify **STRONGBOX®**. Ask for it by name!**

*• [Contact us for a quote on all heights and depths of our chassis.](#) •*

The **STRONGBOX**® Heavy-duty Rack-mount Chassis is the choice of Engineers at:

AT & T	Hughes	
Argonne National Labs	IBM	Union Carbide
Bethlehem Steel	Lockheed	U.S. Air Force
Boeing	Los Alamos National Labs	U.S. Navy
Brookhaven National Labs	MIT	Unisys
CBS Technology Center	Motorola	Westinghouse
FAA Technical Center	Northrop	Xerox
Ford Motor Company	Northstar	
GTE	Raytheon	
General Electric	Reynolds Metals Co.	
General Dynamics	Rockwell	

At **STRONGBOX**®, we take our dedication  
to superior service very seriously.

---

**"Under promise and over deliver"**  
is not just a saying, it's the maxim we live by.

For Price and Performance, specify **STRONGBOX**®. Ask for it by name!

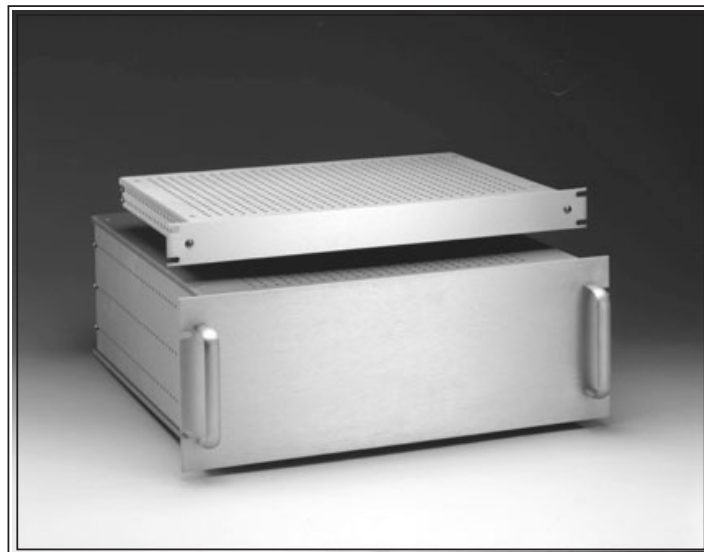

---

*• Contact us for a quote on all heights and depths of our chassis. •*

# Heavy-duty Rack-mount Chassis

Our Chassis are available in six popular EIA Front Panel Heights. Other heights are available.

2U, 3U, 4U, 5U, 6U, and 7U (3½", 5¼", 7", 8¾", 10¼", 12½").

All chassis are available in six popular depths of: 9½", 12", 15", 19", 24", and 26\*". Other depths are available.

Components can be ordered as COMPLETE KITS or as INDIVIDUAL PARTS. Kits and parts come with all required captive machine hardware.

Front, side, and mounting panels are clear iridited. Covers and handles are clear anodized. All surfaces are satin grained. See **Parts and Accessories** descriptions and specifications on pages 5–8.

Complete kits include

**1 Front Panel, 2 Handles, 2 Side Panels, 1 Interior Mounting Panel, and 2 Covers.**

See **Cover Options**, below. Kits can be ordered minus the Front and/or Rear Panels.

Basic dimensional information for popular sizes is given below. Detailed drawings are available on request.

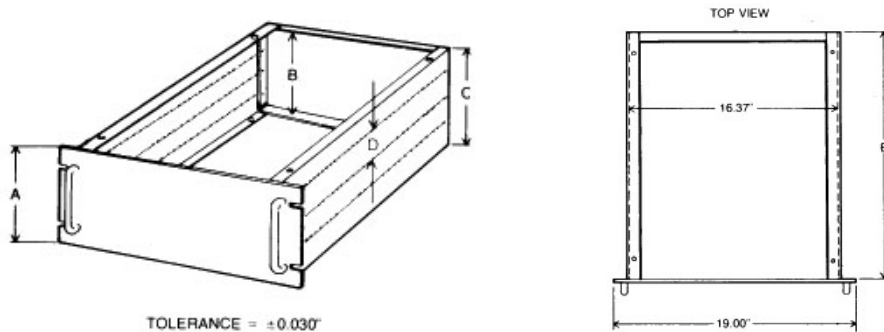

	A	B	C	D	Rack U	E (x)
SBx-3	3.47	2.91	3.15	0.75	2	All kits available in any depth.
SBx-5	5.22	4.66	4.90	1.50	3	
SBx-7	6.97	6.41	6.65	2.00	4	
SBx-8	8.72	8.16	8.40	3.00	5	
SBx-10	10.47	9.91	10.15	3.50	6	
SBx-12	12.25	11.66	11.90	4.00	7	
All kits are in available in any height (U).						

## Cover Options

Use the following table to specify Cover Options.

<b>To Kit Number, add:</b>	<b>to get:</b>
-PAC	two <b>PERFORATED COVERS</b>
-SAC	two <b>SOLID COVERS</b>
-SAC1	one each, <b>SOLID</b> and <b>PERFORATED COVER</b>
-HCP-PAC	one each, <b>HEAVY COVER PLATE</b> and <b>PERFORATED COVER</b>
-HCP-SAC	one each <b>HEAVY COVER PLATE</b> and <b>SOLID COVER</b>

Covers are interchangeable: use on top or bottom.

• **Contact us for a quote on all heights and depths of our chassis.** •

## 1u (1 $\frac{3}{4}$ " ) Heavy-duty Rack-mount Chassis

Introducing the **STRONGBOX**® 1 $\frac{3}{4}$ " high (1 rack unit) by 19" wide, heavy-duty rack-mount chassis.

**SBx-1 chassis** are available in depths of 9 $\frac{1}{2}$ " , 12" , 15" , 19" , 24" , and 26+ " .

The Front Panel is notched to EIA specifications for mounting in your industry-standard 19" rack. It is secured by countersunk screws accessible from the front.

The top Cover may be ordered perforated or solid. The unitized (chassis) bottom is solid.

A rigid Interior Mounting Panel is supplied for use as the chassis rear panel. It may be used, horizontally or vertically oriented, in any one of many pre-drilled positions. Other accessory Interior Mounting Panels are available in several useful sizes.

Order complete kits or individual parts. Each **COMPLETE KIT** contains **1 Front Panel**, **1 unitized Chassis** (sides and bottom), **1 Cover** (see Cover Options note, below), and **1 Interior Mounting Panel**. All parts assemble with provided captive, stainless-steel hardware.

Basic dimensional information is given in the table below. Detailed drawings are available on request.

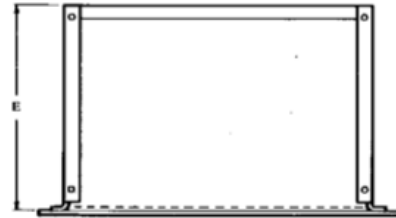
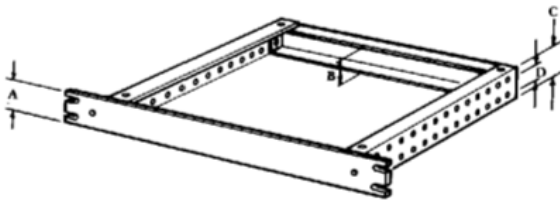

	A	B	C	D	Rack U	Depth
SBx-1	1.72	1.31	0.40	0.50	1	***

\*\*\*All kits available in depths of 9 $\frac{1}{2}$ " , 12" , 15" , 19" , 24" , AND 26" .

### Cover Options

Kits come with a solid-bottom unitized chassis. To get a **PERFORATED** (top) cover add "**-PAC**" to the kit number. To get a **SOLID** (top) cover, add "**-SAC**" to the kit number.

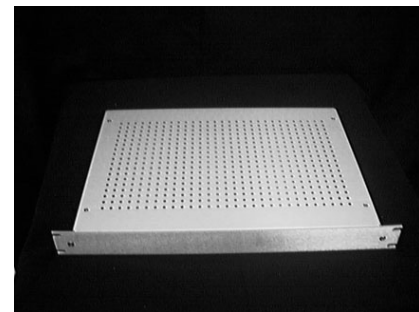
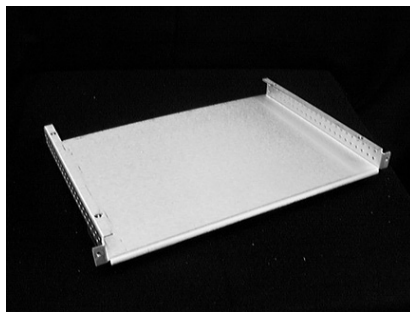

• [Contact us for a quote on all heights and depths of our chassis.](#) •

## Depth Extension Kits (E-Series)

**E-Series Depth Extension Kits** are available off-the-shelf. When mated with **any kit**, they allow assembly of chassis to any depth from 9½" to 33", in ½" increments. Simply attach E-Series Side Panels and Covers to any chassis and adjust to the desired depth.

Basic dimensional information is given below. Detailed drawings are available on request.

**Depth Extension Kit** includes two Extension Side Panels, two Extension (Perforated or Solid) Covers, and all required mounting hardware.

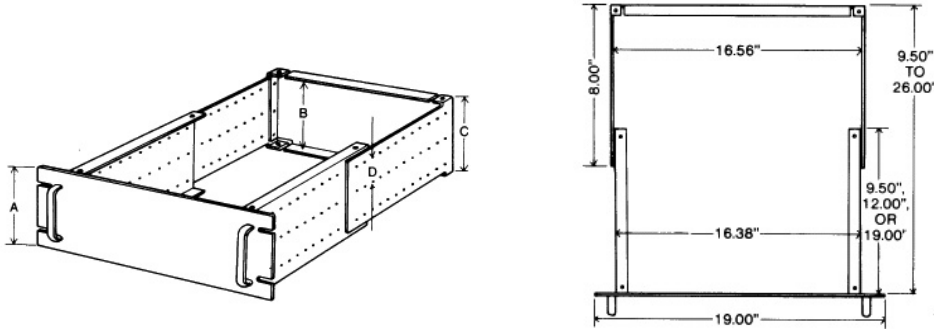

SB9-Series plus E-Series	SB12-Series plus E-Series	SB15-Series plus E-Series	SB19-Series plus E-Series	SB19-Series plus E-Series	SB26-Series plus E-Series
9½" to 16½" deep	12" to 19" deep	15" to 22" deep	19" to 26" deep	24" to 31" deep	26" to 33" deep

### Parts (E-Series)

**E-Series parts** may be ordered separately, as follows:

**Side Panels**

ESP-3, ESP-5, ESP-7, ESP-8, ESP-10, ESP-12

**Covers**

PERFORATED: EPC—SOLID: ESC

### Cover Options

To Kit Number, **add:**

to Get:

-PAC

two PERFORATED COVERS

-SAC

two SOLID COVERS

-SAC1

one each, SOLID and PERFORATED COVERS

Covers are interchangeable: use on top or bottom.

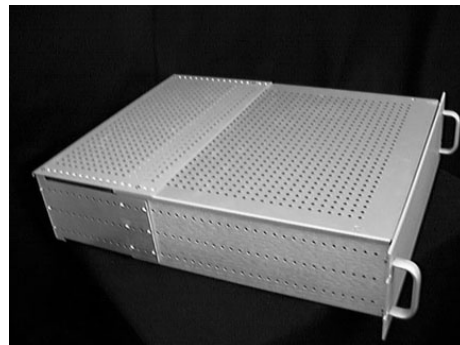
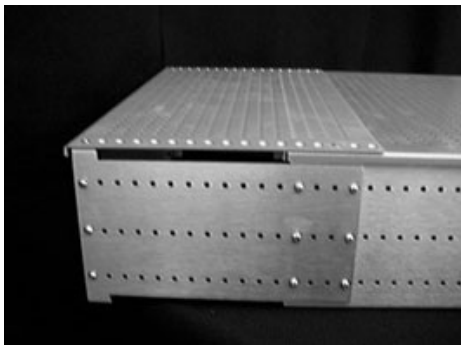

**• Contact us for a quote on all heights and depths of our chassis. •**



## Accessories

### Bottom Mounting Plate (BMP-x)

**Bottom Mounting Plates** are made of 0.090"-thick, 5052-H32 aluminum, textured and clear iridited. Screws, lock washers, and captive nuts are provided for secure attachment to chassis.

A BMP acts as a structural inner floor, supporting extremely heavy subassemblies within the chassis. Depending upon the area of supporting surface required, any BMP of a length equal to or less than chassis depth may be installed in a chassis. A BMP-12 can be very useful in a 19"-deep chassis, for example. All BMPs may be mounted in any one of six possible mounting positions and configurations, using provided rows of Side Panel holes.

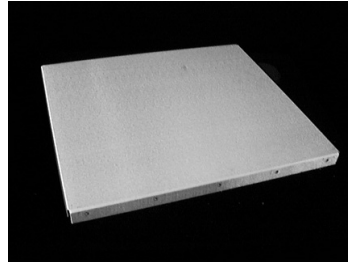
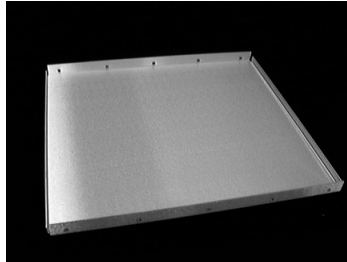

**STRONGBOX**® does not offer a **BMP** to fit the **SB9-x** ( $9\frac{1}{2}$ " deep) Series of chassis kits. An **IMP-8** (see Interior Mounting Panel description) may be mounted horizontally in any **SB9-x** chassis to accomplish this purpose. It will provide all the strength and rigidity such an application requires.

### Mounting Angle

**MA-1.5 Mounting Angle**, for use with the entire line of Heavy-duty Rack-mount Chassis:

The faces (sides) of the **MA-1.5 Mounting Angle** may be drilled, notched, or otherwise modified by the user to attach and support card guides, back planes, circuit boards, and other electronic components within a chassis. They attach to pre-drilled chassis holes in any of four orientations, and may be placed anywhere else in a chassis subject to user modification.

**MA-1.5 Mounting Angles** are cross-chassis bars, not sub-floors or panels, so the flow of cooling air is not impeded. They also increase the torsional stiffness of chassis destined for extremely demanding environments.

Each Mounting Angle is made of 0.090"-thick, clear-iridited aluminum. The **MA-1.5** cross-section in an "L", 0.75" by 1.50". It extends across the full width of the chassis, wall to wall, and attaches with captive stainless-steel hardware.

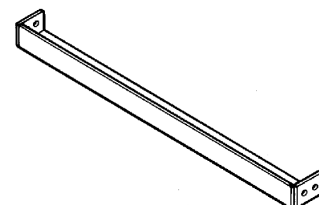
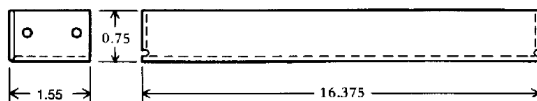
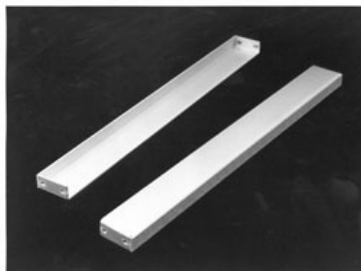

• *Contact us for a quote on all heights and depths of our chassis.* •

## Parts Specification and Descriptions

---

### Handle (SBH-x)

**Handles** are included with each chassis kits. They are oval-sectioned and come with all required hardware for assembly. They are made of lightly textured and clear anodized aluminum.

---

### Front Panel (FP-x)

**Front Panels** are 0.125" thick, made from satin grained and clear iridited 6061-T6 aluminum, EIA notched, and delivered complete with the hardware required to attach the front panel of the chassis to the rack.

**FPS** attach to the chassis Side Panels by means of the same screws which secure the Handles. These screws are installed from behind the Side Panel flanges, on the outside of the chassis.

---

### Side Panel (SP9-y, SP12-y, SP15-y, SP19-y, SP24-y, SP26\*-y)

**Side Panels** of 0.090"-thick 5052-H32 aluminum are grained (textured) lengthwise and clear iridited. Each **SP** features three rows of holds, on  $\frac{1}{2}$ " centers along the panel's entire length for the attachment of Mounting Panels and Plates, chassis Slides, and other accessories and components. Blank Side Panels (without the standard three rows of holes) are available on special order.

---

### Interior Mounting Panel (IMP-x)

**Interior Mounting Panels** are made of 0.090"-thick, 5052-H32 aluminum, grained (textured) lengthwise and clear iridited. Machine screws, lock washers, and captive nuts are provided for secure attachment.

**IMPs** may be used as both horizontal and vertical panels within the chassis interior, to which such components as power supplies, filters, card guides, and connectors may be attached. One **IMP** of appropriate height is included with each chassis kit for use as the rear panel. Others may be ordered as accessory items.

Any **IMP** will fit horizontally in any chassis of any height and depth. Mounting holes are provided in all chassis for this purpose at the bottom, middle, and top of the Side Panels. Any **IMP** equal to or smaller than chassis height will fit vertically in any chassis, but in some cases the user must drill mounting holes in the Side Panels.

---

### Perforated and Solid Cover (PAC-y, SAC-y)

**Perforated and Solid Covers** are made of 0.063"-thick 3003 aluminum, are grained (textured) lengthwise, and are clear anodized. The required mounting hardware is provided.

**PACs** and **SACs** are not meant to be structural supports for components and sub-assemblies. They should only be used as covers. They do, however, lend needed rigidity to the assembled chassis and at least one cover or Bottom Mounting Plate should be assembled to each kit.

More than 66% of a **PAC's** surface is perforated to assure sufficient cooling for internal components. Solid covers are unperforated. Chassis kits are available with two **PACs**, two **SACs**, one of each, or with optional **HCP**.

---

### Heavy Cover Plate (HCP-y)

**Heavy Cover Plates** made of textured and clear iridited, 0.090"-thick, 5052-H32 aluminum. They attach to the chassis using four 6-32 machine screws.

Use **HCPs** to replace one or more covers of a chassis when both the structural support of light to moderate loads and full chassis height are required.

---

• [Contact us for a quote on all heights and depths of our chassis.](#) •

---



## Discount Policy

See Price List.

## Terms

On approved credit: 2/10 – Net 30

1½% per month (18% per annum) charge on accounts unpaid after 30 days.

**New accounts:** to establish an open account, please provide the name, address, and telephone number of your bank and three trade references.

## F.O.B. Point

All Shipments are F.O.B. Carrier will be of seller's choice unless otherwise specified.

## Sales Office Hours

Our Sales Office is open from 9:00AM to 4:00PM (Pacific time) Monday through Thursday, and from 9:00AM to 1:00PM on Friday. Messages may be left anytime on our telephone answering machine at **310.305.8288**. Our e-mail address is "**sales@RackMountChassis.com.**"

## Warranty

Standard parts may be returned for any reason within 30 days for full credit or refund. Parts are warranted against defective workmanship and materials without time limit.

Prior authorization is required before parts will be accepted for return.

## Liability Disclaimer

Neither manufacturer nor seller shall be liable for any injury, loss or damage resulting directly or indirectly from the use of or inability to use the product for the intended use, and user assumes all risk and liability in connection therewith.

## Design Changes

**STRONGBOX**<sup>®</sup> reserves the right to change material and design specifications without prior notice.

## Special Orders

*Chassis of non-standard heights and depths are also available — made to order.*

Call **310.305.8288** for a quote on your special needs.

---

• *Contact us for a quote on all heights and depths of our chassis.* •

**Contact us for a quote on custom parts.**

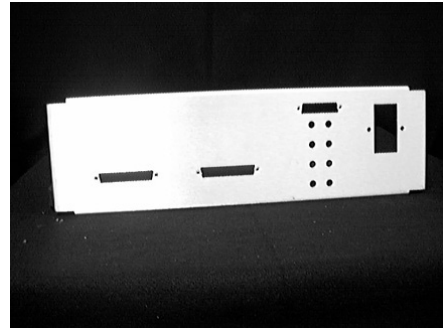
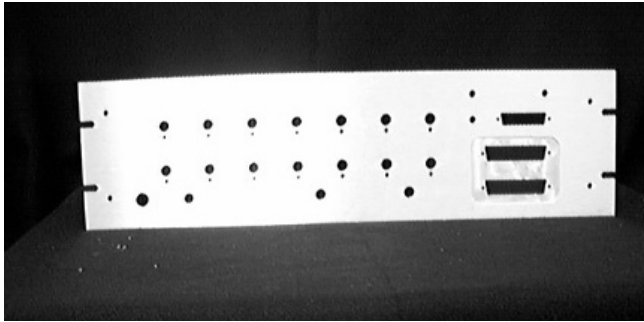

**sales@STRONGBOXmarketing.com**

**310-305-8288**

---

### **Assembly Details**

**Handle—  
Front Panel—  
Side Panel**

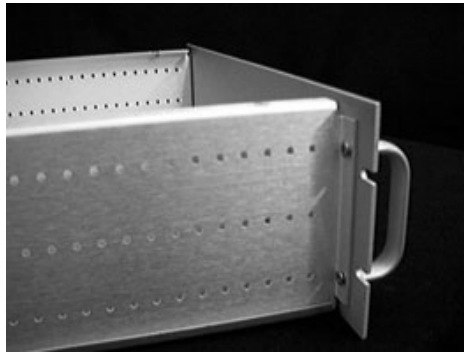

**Rear Panel—  
Side Panel**

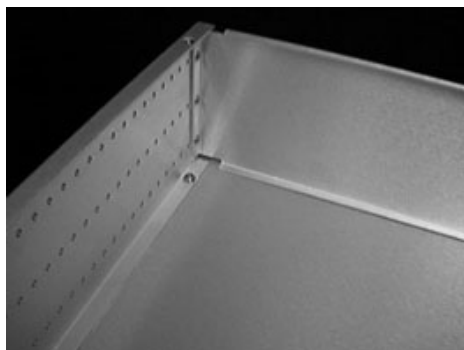

---

*• Contact us for a quote on all heights and depths of our chassis. •*

---